

Airport solutions

www.citconveyors.com

www.selftrust.ro

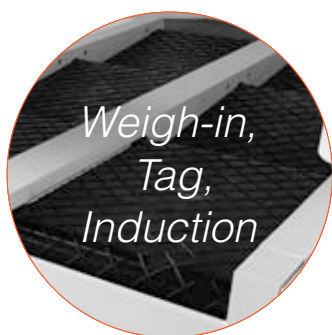

SELF TRUST ROMANIA

Head office and factory

34th Bucium Str, Iasi, 700265
Romania
+4 0232 276 596
office@selftrust.ro

Subsidiary: Maintenance and Sales office

96th Popa Stoica Farcas Str,
3rd district, Bucharest
Romania
+4 021 332 34 05
office2@selftrust.ro

www.selftrust.ro
www.citconveyors.com

Check-in desks

Airport industry

Code: SLF - DSK - BC

Available as single or double units

Custom design

With integrated display and accesories

High end materials and quality finish



Quality finish



Advantages:

Available in different materials:
wood, glass, stainless steel,
composite, stone;
Customisable;
Single stand alone
or double check in;
Integrated;

Custom design



Integrated accesories



Ergonomic



Head office and factory

34th Bucium Str, Iasi, 700265
Romania
+4 0232 276 596
office@selftrust.ro

Subsidiary: Maintenance and Sales office

96th Popa Stoica Farcas Str,
3rd district, Bucharest
Romania
+4 021 332 34 05
office2@selftrust.ro

www.selftrust.ro
www.citconveyors.com

Weigh-in conveyors

Airport industry

Code: SLF - CHK - IS

Single or double units

With 4 point loading cells

Economy solution available (single point cell)

CE, OIML, EAC approved scales



4 loading cells for higher accuracy

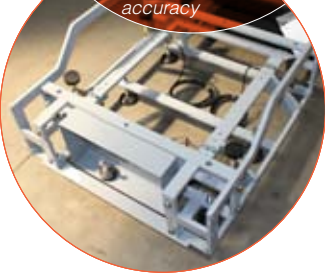

Advantages:

Adjustable configuration;
Weigh-in + (tag) + induction system;
Modular construction
Easy maintenance;
Stainless or composite material finish;

Drum motors



Special accessories

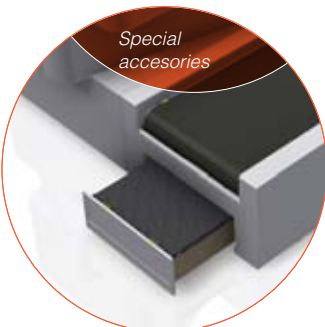

Stainless steel finish



Special materials finish



Head office and factory

34th Bucium Str, Iasi, 700265
Romania
+4 0232 276 596
office@selftrust.ro

Subsidiary: Maintenance and Sales office

96th Popa Stoica Farcas Str,
3rd district, Bucharest
Romania
+4 021 332 34 05
office2@selftrust.ro

www.selftrust.ro
www.citconveyors.com

Return Tray System

Airport industry

Code: SLF - RTS

Standalone unit, Powered

Fitted for accumulation and storage

Available in different dimensions

Can be easily moved (fitted with wheels)



Powered



Advantages:

*Modular design
Can transport different types
of totes
Low power consumption
Silent running
Easy maintenance*

Can
accumulate
totes

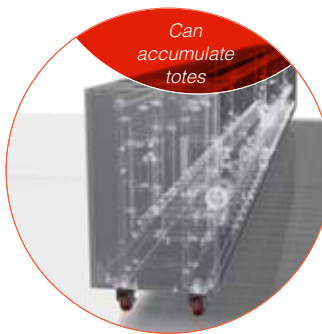

Fitted with wheels
for easy movement

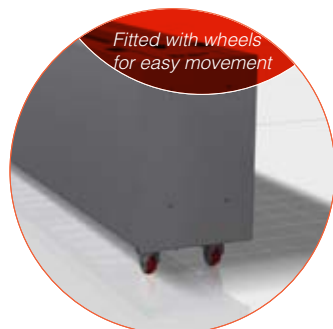

Rollers covered
with special material
for low noise

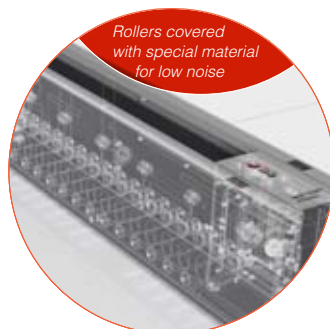

Different lengths available

Head office and factory

34th Bucium Str, Iasi, 700265
Romania
+4 0232 276 596
office@selftrust.ro

Subsidiary: Maintenance and Sales office

96th Popa Stoica Farcas Str,
3rd district, Bucharest
Romania
+4 021 332 34 05
office2@selftrust.ro

www.selftrust.ro
www.citconveyors.com

Reclaim carousels

Airport industry

Code: SLF - TC - U

Length: from 9 to 100 meters

Stainless steel finish

Slats made from fire retardant materials

Available shapes: O, L, T, U; horizontal or inclined transport



Caterpillar drive

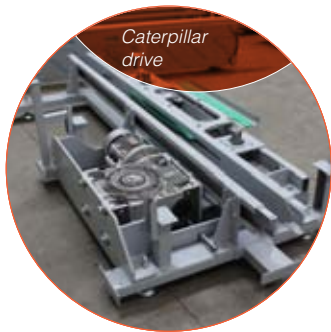

Advantages:

*Adjustable configuration according to existing layout;
Low noise;
High transport capacity;
Low maintenance;
Stainless finish;*

Slats made from fire retardant materials

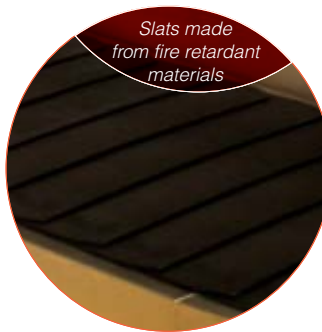

Stainless finish



Load up to 100 kg/ml



Different shapes



Head office and factory

34th Bucium Str, Iasi, 700265
Romania
+4 0232 276 596
office@selftrust.ro

Subsidiary: Maintenance and Sales office

96th Popa Stoica Farcas Str,
3rd district, Bucharest
Romania
+4 021 332 34 05
office2@selftrust.ro

www.selftrust.ro
www.citconveyors.com

Baggage handling systems

Airport industry



Scalable systems
Standardised components
3d Environment simulation
For small and medium airport
Complete solution



3D Environment simulation



Advantages:

Modular solution;
Up to 5 level of security;
High processing capacity;
Low maintenance;
Low noise;
Integrated automation;

Standardised components



Integrated

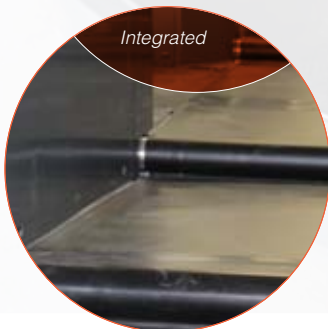

Quality finish

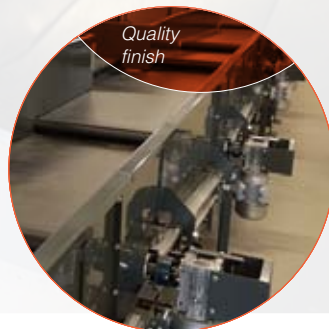

Complete customised solutions.

Head office and factory

34th Bucium Str, Iasi, 700265
Romania
+4 0232 276 596
office@selftrust.ro

Subsidiary: Maintenance and Sales office

96th Popa Stoica Farcas Str,
3rd district, Bucharest
Romania
+4 021 332 34 05
office2@selftrust.ro

www.selftrust.ro
www.citconveyors.com

Zero Gap Power Diverter

Airport industry

Code: SLF - TDO

Powerfull and robust structure

Free gap transfer

High Troughoutput

Available on left or right transfer

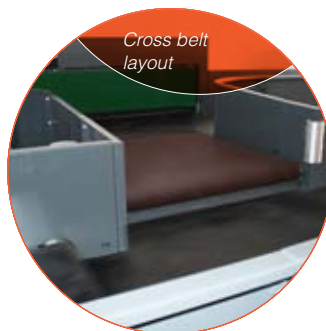
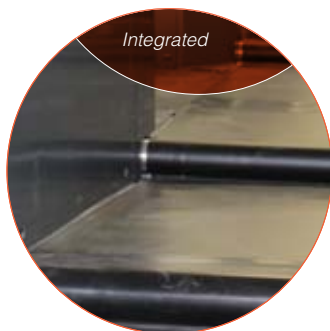
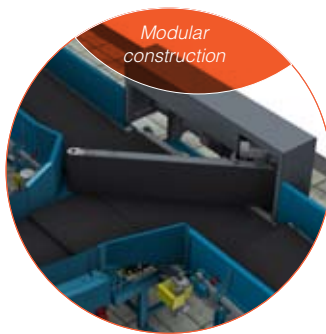
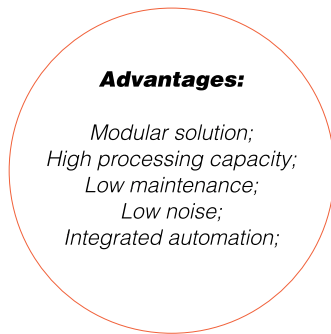

Head office and factory
34th Bucium Str, Iasi, 700265
Romania
+4 0232 276 596
office@selftrust.ro

**Subsidiary: Maintenance
and Sales office**
96th Popa Stoica Farcas Str,
3rd district, Bucharest
Romania
+4 021 332 34 05
office2@selftrust.ro

www.selftrust.ro
www.citconveyors.com

Check-in desks Weigh-in conveyors

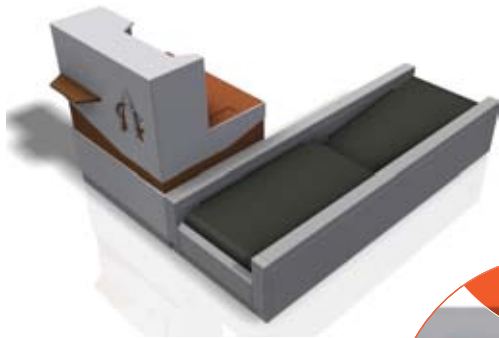

Made from wooden panels (ash or other hardwood) and Corian
With 4 point loading cells
Economy solution available (single point cell)
CE, OIML, EAC approved scales

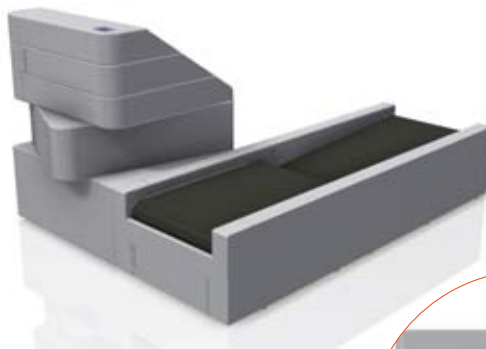
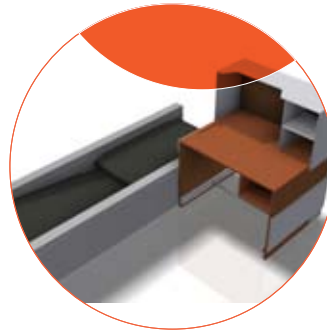

Desk made from Corian, with integrated display and command console
Weigh-in conveyor covered completely in Corian
Unitary design



Check-in desk and weigh-in available as double units
Desk made from Corian,
Weigh-in conveyor covered completely in Corian
Ergonomic design

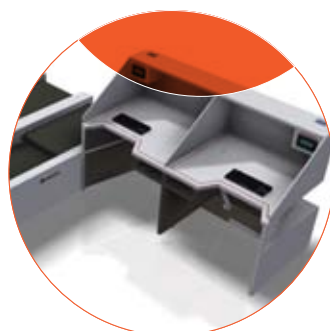

Head office and factory

34th Bucium Str, Iasi, 700265
Romania
+4 0232 276 596
office@selftrust.ro

Subsidiary: Maintenance and Sales office

96th Popa Stoica Farcas Str,
3rd district, Bucharest
Romania
+4 021 332 34 05
office2@selftrust.ro

www.selftrust.ro
www.citconveyors.com

Baggage handling systems

Linear layout, for 150 baggages / hour



Required space: 24 x 4 meters
 4 Check in Desks
 4 Double stage units (Weigh and Induction)
 Collecting conveyors
 For small and medium airport
 Complete solution
 *The X-Ray machine available on request

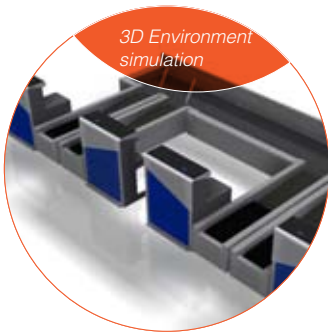
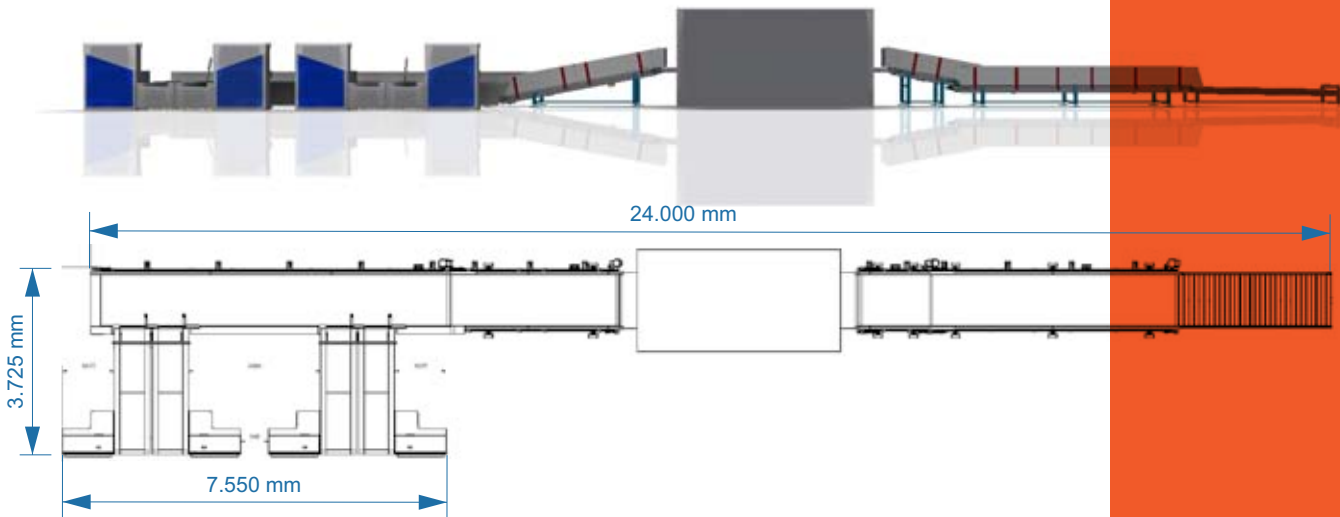
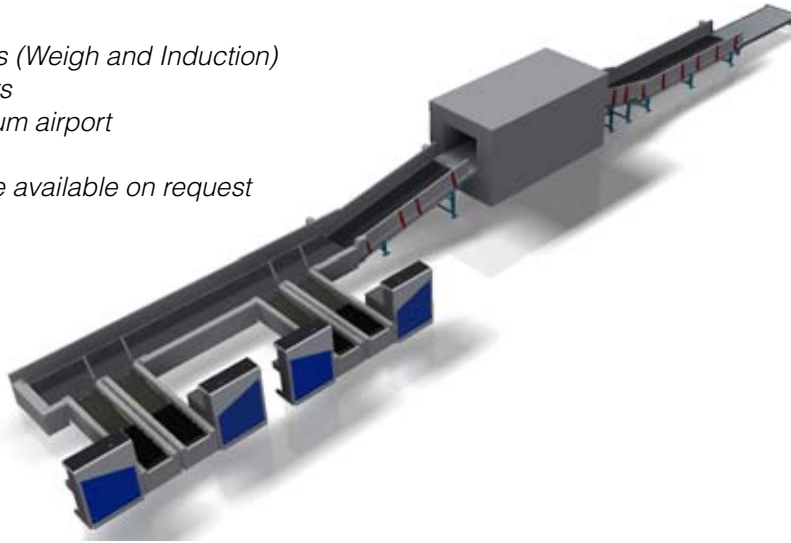

Advantages:

- Modular solution;
- High processing capacity;
- Low maintenance;
- Low noise;
- Integrated automation;

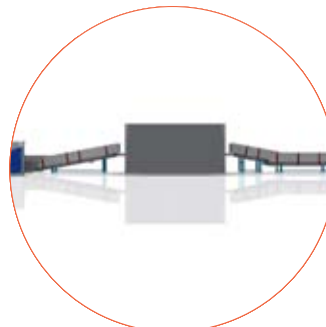
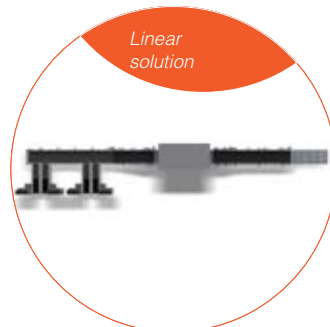
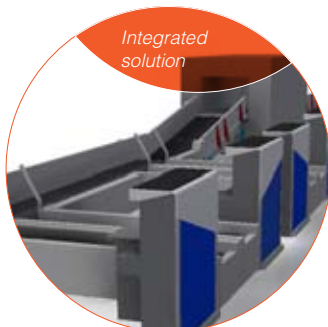
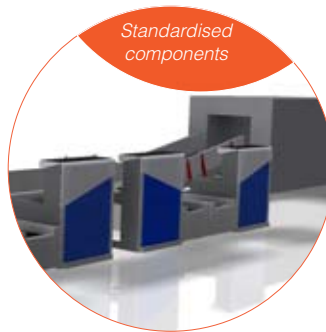

Head office and factory
 34th Bucium Str, Iasi, 700265
 Romania
 +4 0232 276 596
 office@selftrust.ro

Subsidiary: Maintenance and Sales office
 96th Popa Stoica Farcas Str,
 3rd district, Bucharest
 Romania
 +4 021 332 34 05
 office2@selftrust.ro

www.selftrust.ro
 www.citconveyors.com

Baggage handling systems

Compact layout, for 180 baggages / hour



Required space: 12x 7 meters

Compact solution

5 Check in Desks

5 Double stage units

(Weigh and Induction)

3 collecting conveyors

Complete solution

*The X-Ray machine
available on request

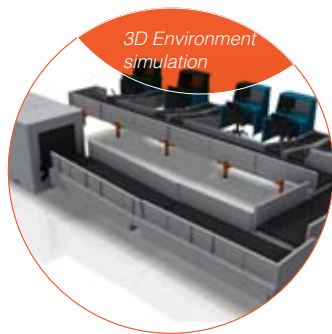
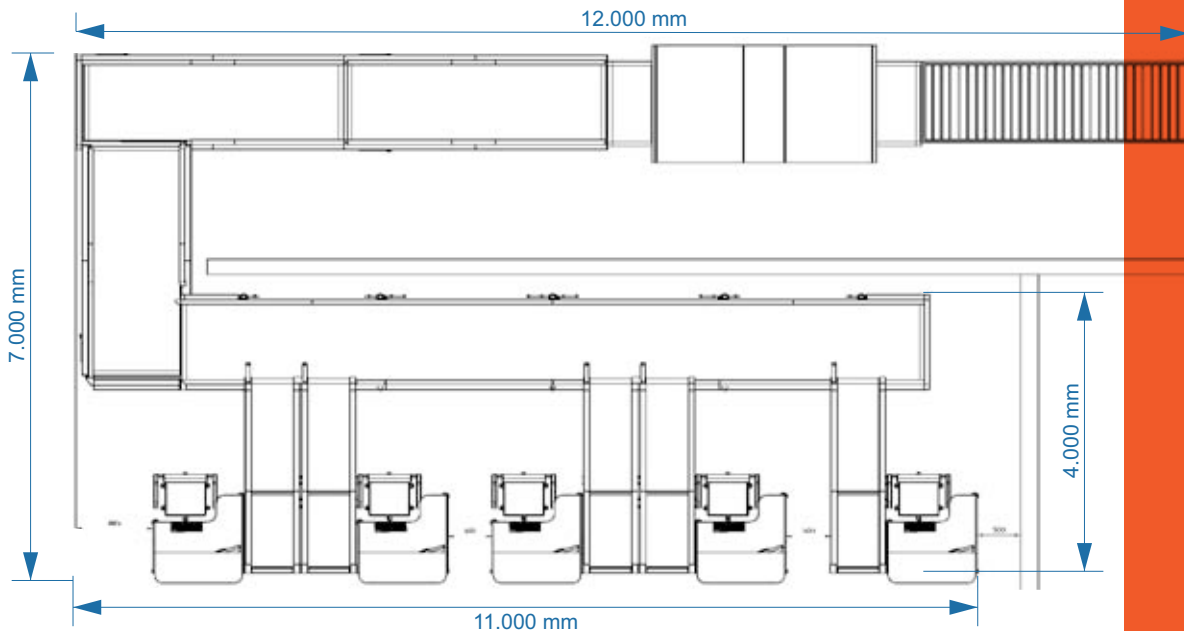
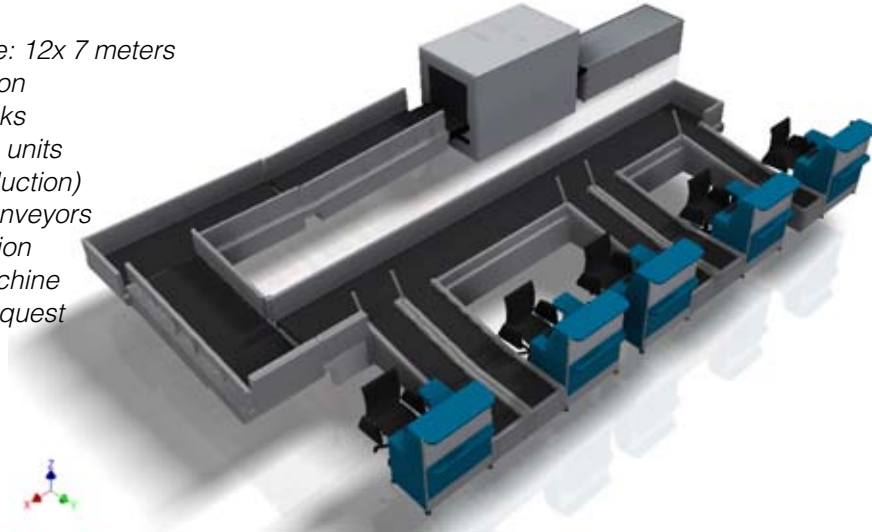

Advantages:

- Small footprint;
- Turnkey solution;
- Easy to upgrade system;

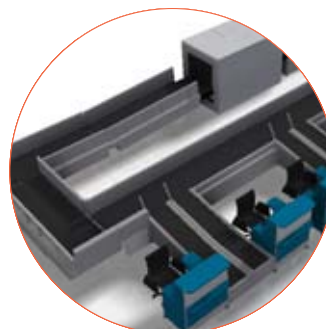
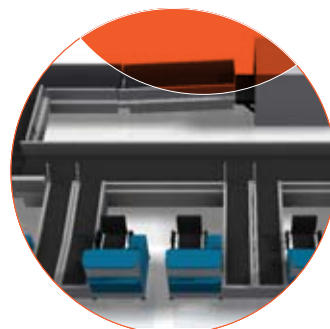
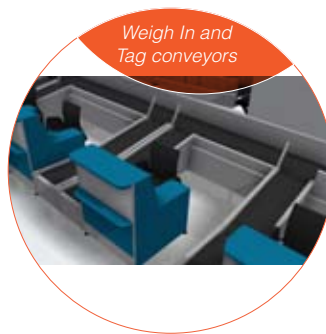

Head office and factory
34th Bucium Str, Iasi, 700265
Romania
+4 0232 276 596
office@selftrust.ro

Subsidiary: Maintenance and Sales office
96th Popa Stoica Farcas Str,
3rd district, Bucharest
Romania
+4 021 332 34 05
office2@selftrust.ro

www.selftrust.ro
www.citconveyors.com

Baggage handling systems

Complex layout, for 500 baggages / hour

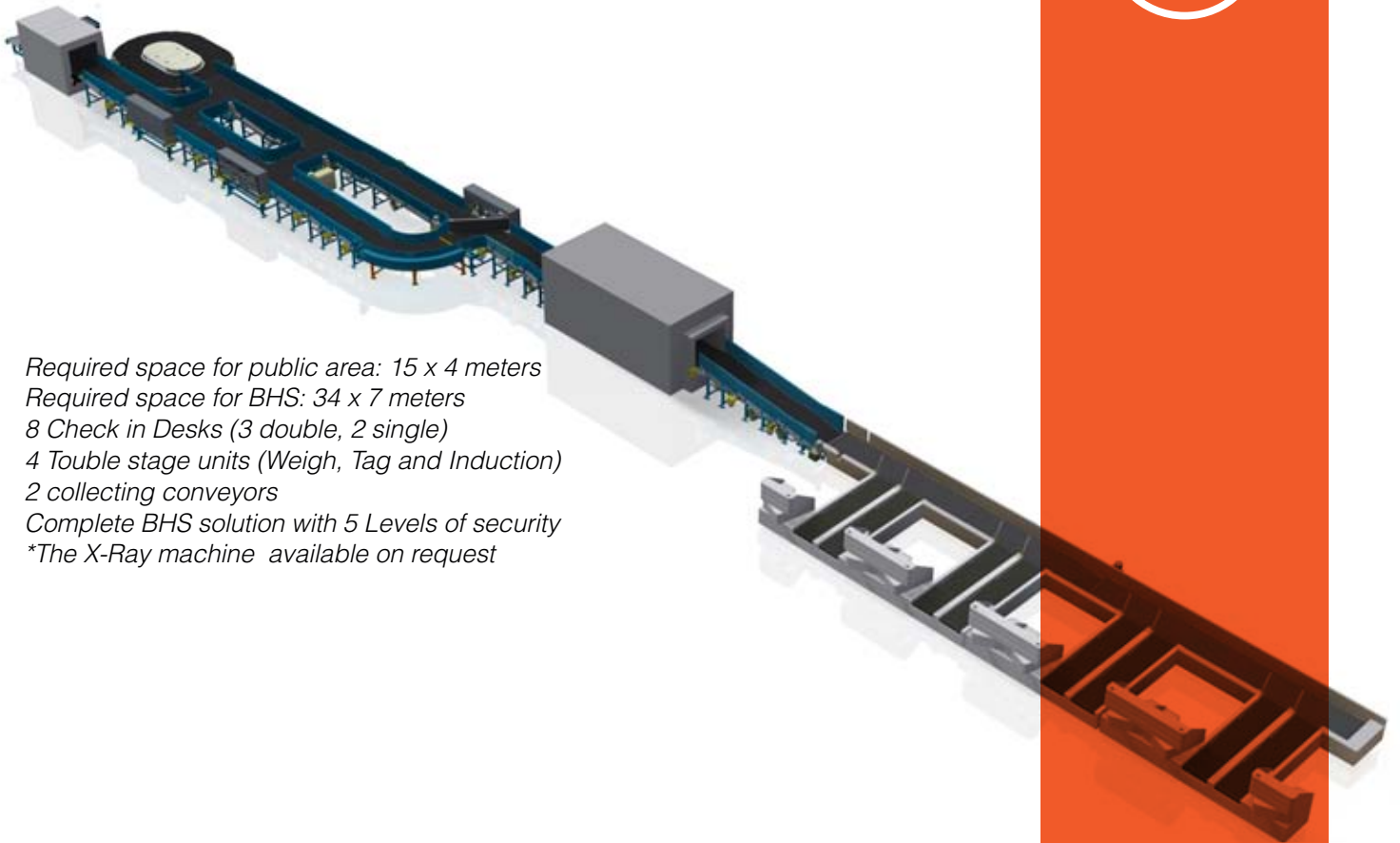

Required space for public area: 15 x 4 meters
Required space for BHS: 34 x 7 meters
8 Check in Desks (3 double, 2 single)
4 Touble stage units (Weigh, Tag and Induction)
2 collecting conveyors
Complete BHS solution with 5 Levels of security
*The X-Ray machine available on request

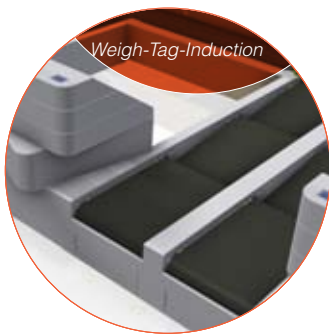

Advantages:

Modular solution;
Up to 5 level of security;
High processing capacity:
500 baggages/hour;

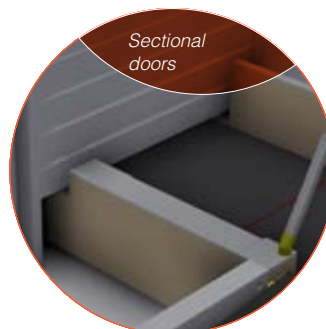
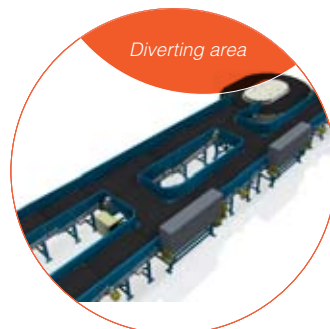
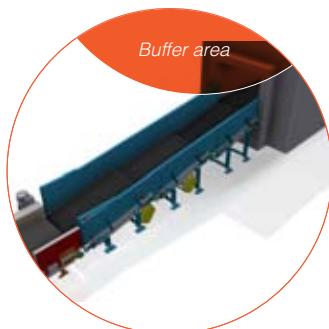
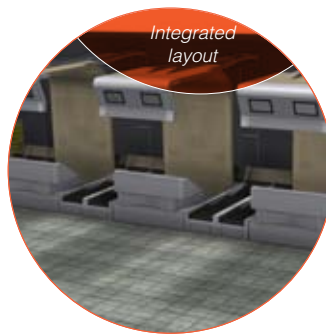

Head office and factory

34th Bucium Str, Iasi, 700265
Romania
+4 0232 276 596
office@selftrust.ro

Subsidiary: Maintenance and Sales office

96th Popa Stoica Farcas Str,
3rd district, Bucharest
Romania
+4 021 332 34 05
office2@selftrust.ro

www.selftrust.ro
www.citconveyors.com



Brief History

CITCO (romanian acronym for Industrial Reasearch Center in Conveyor Technology) is a division of SELF TRUST ROMANIA, a company established in 1999, specialized in conveyor manufacturing.

CITCO's engineers are designing solutions for a large number of industrial applications, starting from the simplest conveyor types working individually to complex transport systems. Our customized transport systems can reach a degree of high complexity within the projects involving the integration of the systems in the manufacturing lines.

Team

We are a young and dynamic team, formed in the last 15 years with the goal of becoming one The best conveyor manufacturer.

Our motivations comes from our satisfied clients and well done projects.

With a team of over 70 employees, out of which 9 are design engineers, SELF TRUST ROMANIA answers with promptitude and offers solutions adjusted to the requests of each of our customers.

Our Designing Department uses Autodesk Factory Design Suite Ultimate, Math CAD and Math LAB programs for designing the most detailed projects.

Machineries

SELF TRUST ROMANIA has invested over 4 million Euro to build a new factory and in a second metal processing line (cutting, bending, punching). The Industrial Reasearch Center in Conveyor Technology - CITCO was a part of 1.1 million Euro from the total investment and it was implemented with European Union support.

The investment included the following equipments:

*Hydraulic shear for steel sheets - 4050 x 13 mm
Hydraulic press brake - 4000 mm x 220 To
CNC machining Minicentre - 4 axes, 500x900 mm table
CNC lathe - 700x2100 mm
Waterjet cutting machine OMAX - 5 axes, 3000 x 2000 mm table
Other equipments*



Head office and factory

*34th Bucium Str, Iasi, 700265
Romania
+4 0232 276 596
office@selftrust.ro*

Subsidiary: Maintenance and Sales office

*96th Popa Stoica Farcas Str,
3rd district, Bucharest
Romania
+4 021 332 34 05
office2@selftrust.ro*

*www.selftrust.ro
www.citconveyors.com*